

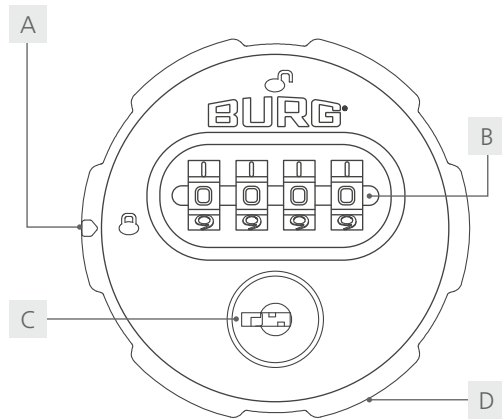

sPinLock 200
Operating Manual

sPinLock 200



- A Status indicator
- B Guide line
- C Opening for Master Key
- D Turning knob

Introduction

Dear Customer,
Thank you for choosing the **sPinLock 200** - the code combination lock for various applications in the furniture sector.

The sPinLock 200 is suitable for use in steel and wooden furniture. It has four number wheels for free code selection, additional master key function with code finding possibility.

Important: Please note all warnings and read through the entire operating manual before you begin configuration.

We hope you enjoy using your new locking system.

Sincerely, BURG F.W. Lüling KG

General

The latest version of this guide is always available at:
www.burg.de

Content

| | |
|-----------------------------|---|
| Introduction..... | 2 |
| General..... | 2 |
| Default settings..... | 2 |
| Technical data..... | 3 |
| Scope of delivery..... | 3 |
| Optional accessories..... | 3 |
| Features..... | 3 |
| Dimensions..... | 3 |
| Mounting dimensions..... | 3 |
| Assembly instructions..... | 4 |
| Functional description..... | 5 |
| Configuration..... | 5 |
| Operation..... | 6 |
| Contact..... | 6 |

Default Settings

| | |
|---------------|---------|
| Standard code | 0-0-0-0 |
|---------------|---------|

Factsheet



| Technical Data | |
|--------------------------|--|
| Dimensions | 107 x 56 x 13 mm |
| Material | Housing: Plastic Mounting socket: Zamak Latch: Steel (nickel-plated) |
| Mode | Multi User Mode |
| Number wheels | 4 |
| No. of code combinations | 9,999 |
| Locking direction | L, R |
| Mounting hole | 16 x 19 mm |
| Lock attachment | M19 nut |
| Max. door thickness | 18 mm |

Dimensions

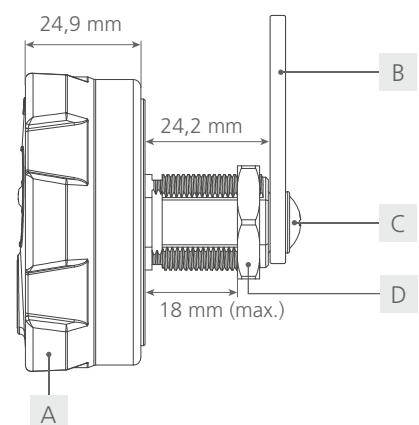
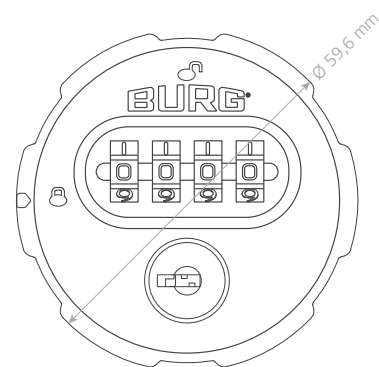

Scope of Delivery

- | | |
|----------------|-----------|
| A sPinLock 200 | B Latch |
| C Fixing screw | D M19 Nut |

Optional Accessories

- Master Key
- Anti-twist protection

Features

- Ergonomic handling
- Multi user function
- Emergency opening and code access by master key
- Eavesdropping protection
- 9,999 possible code combinations

Mounting Hole Dimensions

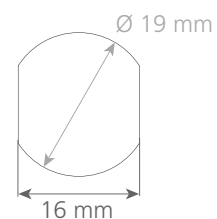

Assembly Instructions

- 1 Prepare the appropriate mounting hole (16 x 19 mm) on your furniture. Make sure that the bolt included in the scope of delivery reaches behind the strike plate (not included in the scope of delivery) or behind an existing rebate of your piece of furniture (min. 4 mm) when mounted and when the door is closed. Only then drill the mounting hole required for installation.

Tip: If you produce furniture in a larger quantity using CNC milling, the use of 3D step data is recommended.

- 2 Place the lock on the door and push the shank through the mounting hole. Make sure that you place the lock straight.

- 3 Place the nut on the thread and tighten the lock sufficiently.

Note: For wooden furniture, the mounting hole can be drilled circularly. In this case the use of an anti-twist protection is recommended. During assembly, the anti-twist protection is placed on the thread and screwed tight with the nut.

- 4 To simplify the installation of the bolt, bring the lock into the open position. Then place the bolt on the cross bar of the shank so that it is in the open position and hold it in place.

- 5 Fasten the latch with the screw. Check if the latch can close as desired. Ideally, the lock can be closed easily without the bolt being under tension.

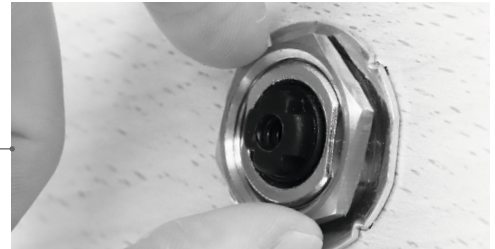

Functional Description

Mode: Multi User Authorization (Multi User Mode)

This mode is suitable for constantly changing users who only use the compartment temporarily or once, e.g. in a sports facility. A new code can be set after each opening process.

Note: It is not mandatory to set a new code. Alternatively, the code already set can be retained.

Master Key

The lock can be opened via the master key if the code is lost.

Note: The master key is not included in the scope of delivery and can be ordered separately.

Configuration

1 Set the Code

1. Bring the lock into the open state. To do this, set the valid code (factory setting 0-0-0-0) using the number wheels and turn the knob 90 degrees to the right until the status indicator points to the open lock symbol.

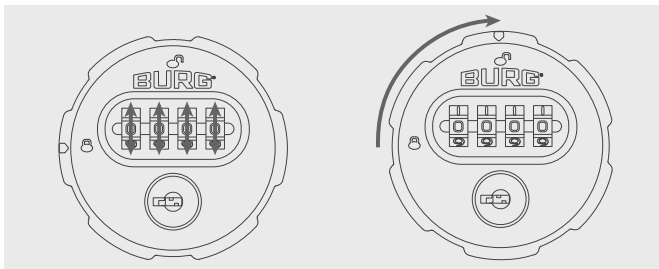

2. When open, set your preferred code by moving the number wheels to the appropriate position. Orientate yourself on the guide line. When the lock is locked (turn counterclockwise and adjust the number wheels), this code is valid.

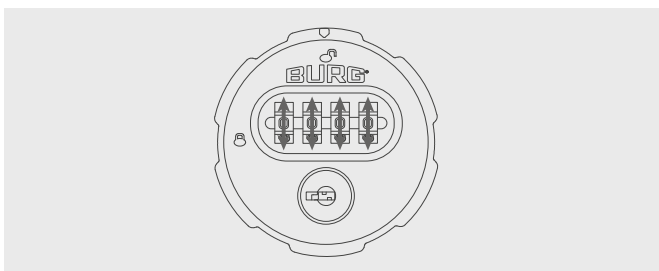

2 Code Finding and Master Key Opening

You have the possibility to open the lock with the master key if the code has been lost. This process also allows you to read the valid code.

1. First insert the master key into the opening provided for it (page 2) and turn it 90 degrees to the right.

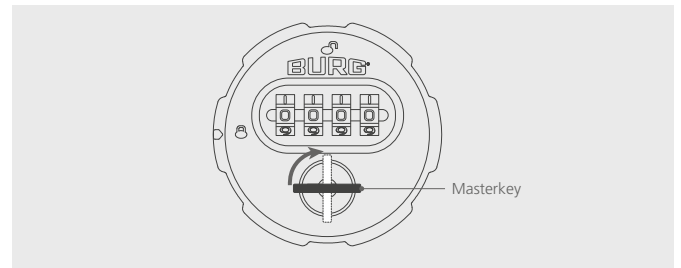

2. While the key remains in this position, carefully turn each number wheel individually from top to bottom until they stop, starting with the left number wheel. Be careful not to move to the next number wheel until the previous number wheel has stopped at the correct position. When all number wheels are in the correct position, you can read the valid code.

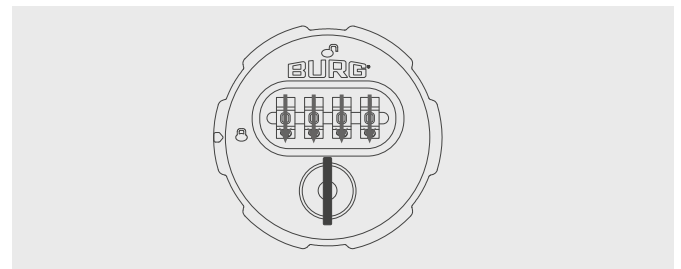

3. Turn the key 90 degrees to the left and remove it

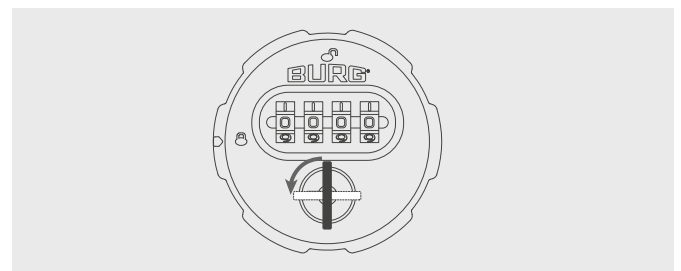

4. Turn the knob 90 degrees to the right until the status indicator points to the open lock symbol. The lock is now opened.

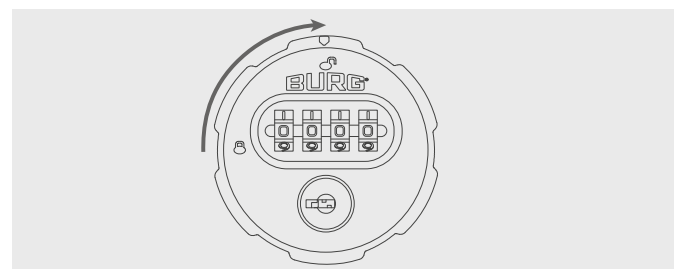

Operation

1 Locking

1. You have the possibility to lock the lock with a preset code or a new code. If you would like to use a new code to close the lock, follow the steps under point 1 „Set the Code“.

2. Turn the knob 90 degrees to the left so that the status indicator points to the closed lock symbol. Turn the number wheels to lock the lock.

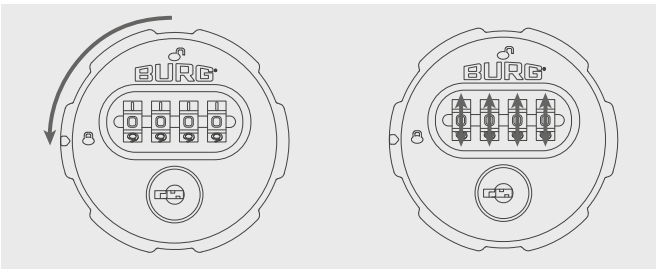

2 Unlocking

1. Open the lock by setting the code used to close it using the number wheels. Use the guide line (page 2) for orientation.

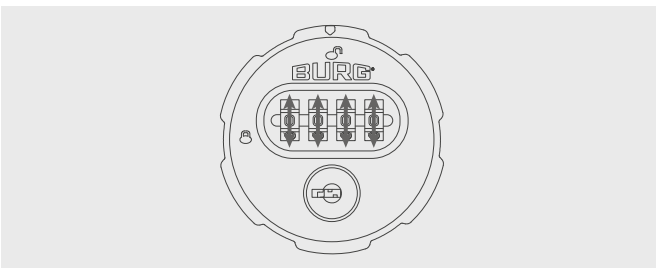

2. Turn the knob 90 degrees to the right until the status indicator points to the open lock symbol.

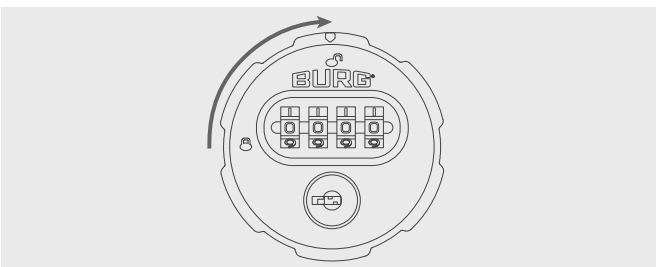

Contact

BURG F. W. Lüling KG

Hegestraße 6
58300 Wetter (Germany)

Fon +49(0)23 35. 63 08-0
info@burg.de
www.burg.de